

Light Industrial Barcode|RFID Printer Quick Start Guide

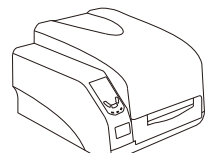

This Guide will assist with set up for Postek Light Industrial Barcode and RFID printers.
For a full overview of the printers please refer to the User's Manual.

Packing List



Printer × 1



Interface Cable × 1

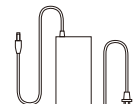

Power Adapter × 1



Media Spindle × 1



Media Roll Guide × 2

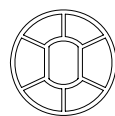

Media Core Adapter × 2

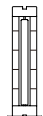

Ribbon Spindle × 2



Ribbon Core × 1

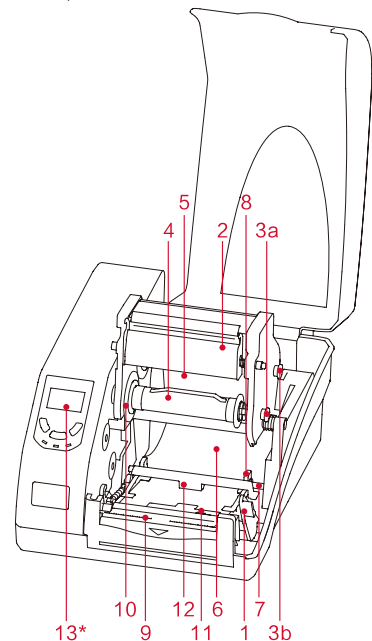

- | | |
|-----------------------|------------------------------|
| 1 Release Lever | 9 Tear Bar |
| 2 Printhead Module | 10 Left Ribbon Mount |
| 3 Ribbon Loading Knob | 11 Reflective Media Sensor |
| 4 Ribbon Supply | |
| 5 Ribbon Take-up | 12 Transmissive Media Sensor |
| 6 Media Compartment | 13* LCD Panel |
| 7 Media Guide Rod | |
| 8 Media Guide | |

*Not applicable for all models

Loading the Ribbon

* **Note:** Loading the ribbon only when using the thermal transfer printing method.

The G Series supports ribbons with ink on the outside by default. Please check the ribbon first. If the width of Ribbon is less than 110mm, place the ribbon in the middle of the Ribbon Spindle for proper alignment (pictured at right).

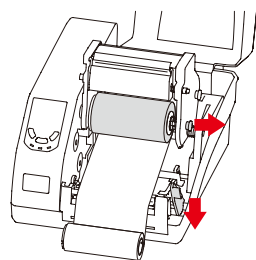
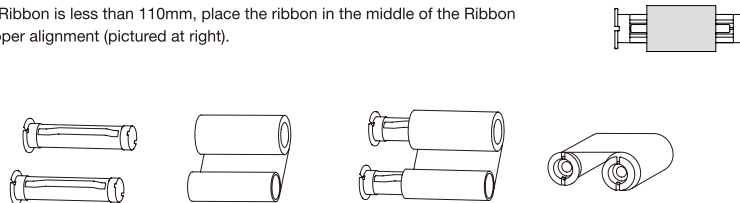

01/ Lift the top cover and push the Printhead Release Lever downward to release the Printhead Module.

Pull out the Ribbon Release Knob on the Ribbon Supply and mount the ribbon onto the Ribbon Supply.

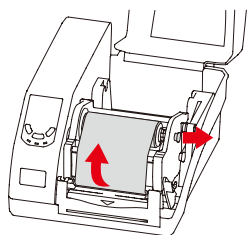

02/ Pull out the Ribbon Release Knob on the Ribbon Take-up, route the ribbon through the Printhead Module, and wrap the end of the ribbon around the Ribbon Take-up.

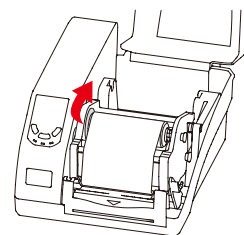

03/ Tighten the ribbon by turning the guide wheel on the left of the Ribbon Take-up.

Loading the Media

* **Note:** Media Core Adapter is not required when using media roll with small- sized media core.

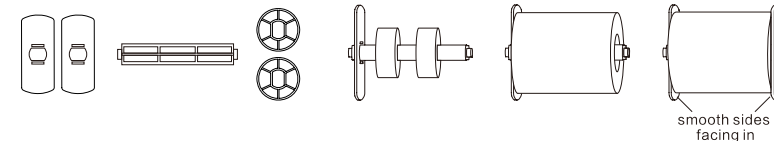

smooth sides facing in

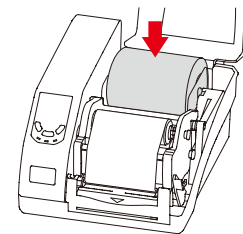

01/ Place the loaded media spindle in the centre of the Media Compartment.

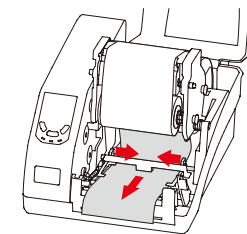

02/ Lead the media through the bottom of the Media Guide Rod, slide the Media Guide close to the edge of the media, making sure that the media remains flat and is put in the middle of the dividing rule.

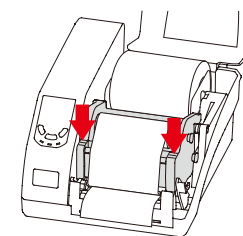

03/ Press the Printhead Module downward until you hear a "click", which indicates the hard lock of the Printhead Release Lever.

Connect the Printer to PC

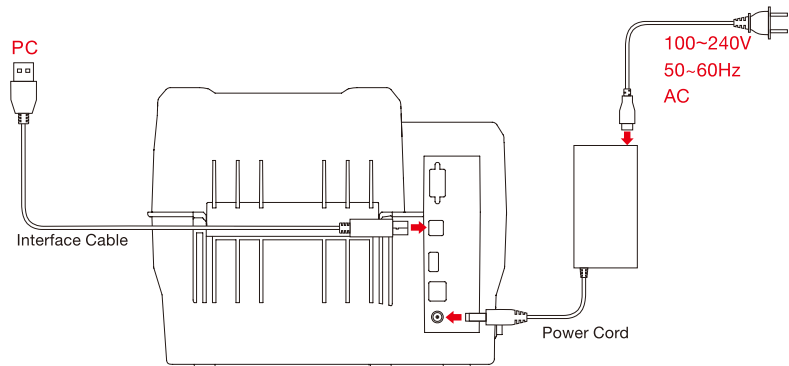

Media Calibration

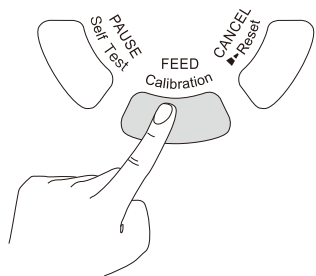

Turn on the printer, press and hold the “FEED” button for 2 seconds. Then the printer will automatically feed 3-4 labels (approx. 200 mm of labels), and the media calibration is done. The printer is ready to print.

The Location of Media Sensor

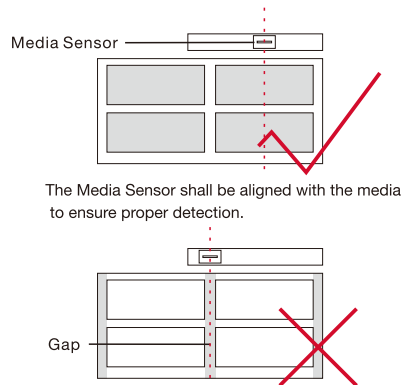

The Media Sensor shall be aligned with the media to ensure proper detection.

The Media Sensor cannot detect the label length correctly when it is positioned at the gap between labels in the same row.

Troubleshooting

- 1. Printer is on; however, the indicator lights are off.**
Confirm the power adapter's indicator light is on. If the indicator light is not on, this indicates a faulty power adapter.
- 2. The label software cannot work after installation.**
Ensure the G Series Windows driver is installed correctly.
- 3. Error message “Error Can Not Print” appears.**
Check for proper connection of the interface cable, and if more than one Postek printer driver is installed on your computer, make sure the G Series printer is selected in the label software.
- 4. Error message “Print” appears, and the READY and RIBBON indicators blink simultaneously.**
Check whether the ribbon has been correctly loaded (see “Loading the Ribbon”).
- 5. There is no printout on the media after printing.**
 - a. Confirm that the ribbon has ink on the outside only (the G Series support ribbons with ink on the outside). Besides, make sure that the type of ribbon used is appropriate for the type of media. For example, Resin ribbons mainly match Silver Membrane labels.
 - b. Confirm labels are formatted correctly.
- 6. Printout on media is not clear.**
 - a. Make sure that the type of ribbon used is appropriate for the type of media. For example, Resin ribbons mainly match Silver Membrane labels.
 - b. Increase the Darkness value in the label software.
- 7. Upon clicking the Print command, READY and MEDIA indicator lamps blink.**
Confirm the media sensor is properly positioned (see “The Location of Media Sensor”) and perform a media calibration (see “Media Calibration”).

Declaration

Postek Electronics Co., Ltd.

WWW.POSTEKCHINA.COM is the official website of Postek Electronics Co., Ltd. Additional product and Service information are available on WWW.POSTEKCHINA.COM

Trademarks **POSTEK** and **POSTEK**, and the copyright of this material belong to Postek Electronics Co., Ltd. They are protected under the law of People's Republic of China.